

# DOC 303

- 5 m / 5,7 m - Voor tractoren 70-90 pk / For tractors 70-90

ACHTEROP GEPLAATSTE ARMMAAIER  
REAR HEDGE MOWERS



DOC 303 5.0	Prijs op aanvraag
DOC 303 5.7	Prijs op aanvraag

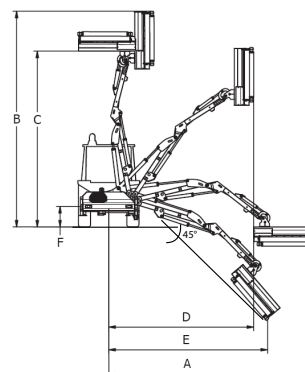

DOC 303	5.0	5.7
A (mm)	5.000	5.700
B (mm)	5.200	5.900
C (mm)	4.100	4.800
D (mm)	4.000	4.700
E (mm)	3.200	3.900
F (mm)	550	550

Hydraulische bosmaaier met arm met side shift met schokbestendige hydraulische beveiliging voor tractoren van 70/90 pk en 3000/3500 kg gewicht, ideaal voor werkzaamheden in stedelijke gebied en langs buitenwegen en voor agrarische bedrijven.

Hydraulic hedge mower with side shift and mechanical release safety device for tractors HP 70/90 and weight 3000/3500 kg, suitable for working on local and trunk roads and farms.

ARM MAAIER- ARM MOWER

TRACTOR - TRACTOR

Model Model	Reikwijdte Extension E (mm)	Gewicht Weight (kg)	Olietank Oil tank (L)	Type kop Head (model)	Pomp Pump (l/min)	Hydr. Motor Hydraulic Motor (HP [kW])	Vermogen Power (HP [kW])	3 punts ophan- ging 3-point linkage	Gewicht Weight (kg)	Breedte Width (m)	PTO (tpm (rpm)
DOC 303 5.0	5.000	820	150	30.3	80+20	45 (33)	70 / 90	Cat. 1-2	3.000	2	540
DOC 303 5.7	5.700	880	150	30.3	80+20	45 (33)	70 / 90	Cat. 1-2	3.500	2,2	540



SCHOKBESTENDIGE HYDRAULISCHE BEVEILIGING  
MECHANICAL RELEASE SAFETY DEVICE

## TECHNISCHE SPECIFICATIES EN STANDAARD UITRUSTING

- Frame – 1e en 2e arm uitgevoerd in hoogwaardig staal ST.52
- Drie punts ophanging CAT2
- Hydrauliek olietank 150 liter
- Dubbele tandwielgroep groep 3+2 - 80+20 lt/min
- Bidirectionele hydro motor, vermogen 45 PK
- Kabelbediening met remote control, flexibele kabel, 3000 mm
- Zwevend zelfnivellerend systeem
- Looprol verstelbaar in 3 standen
- Draaihoek van de maaikop 200° met bovenaansluiting
- Spiraalvormige rotor met onderbroken snijmes - KC2
- Rotorsnelheid 3000 tpm
- Spanner bevestiging
- Kruis koppeling
- Achterbalk met verlichting
- Klepelmaaier 1050 mm MODEL 30.3 TTD 105 met directe overbrenging

## TECHNICAL FEATURES AND STANDARD EQUIPMENT

- Frame - 1st arm - 2nd arm in structural steel ST 52
- Three points attachment 2nd category
- Oil tank 150 l
- Double gear pump group 3+2 - 80+20 l/min
- Bidirectional hydraulic motor HP 45 power
- Distributor with remote controls with mm 3000 flexible cables
- Self-levelling floating system
- Feeler roller recordable on 3 positions
- Head rotating angle 200° with upper attachment
- Helicoidal rotor with jointed cut blade KC2
- Number revs to rotor 3000 rpm
- Fixing tie-rods
- Cardan joint
- Rear underrun protection with lights
- Flail head mm 1050 MODEL 30.3 TTD 105 with direct transmission

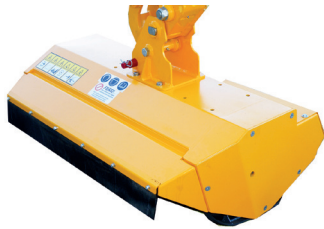

### KC2

Ø max 2 cm

Standaard uitrusting  
standard equipment

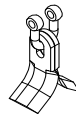

### KC3

Ø max 2 cm

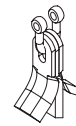

### HC1

Ø max 4 cm

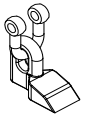

### KF2

Ø max 3 cm



### KF3

Ø max 3 cm

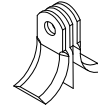

### HF3

Ø max 6 cm



## OPTIES OP AANVRAAG / MEERPRIJS

- Stikstofaccumulator voor 1e armophanging
- Oliekoeler
- Aan/Uit elektro-hydraulische bediening met joystick
- Klepelmaaier 1250 mm
- Achteraansluiting
- Proportionele servo met joystick
- Aankoppeling adapter CAT 1-2

## ACCESSORIES ON REQUEST

- Nitrogen accumulator for 1st arm suspension
- Heat exchanger
- On-off electro-hydraulic distributor with joystick
- Flail head mm 1250
- Rear attachment
- Power-assisted with joystick
- Tie rods adapter Cat. 1 o 2

## AANKOPPELGEREEDSCHAP - TER VERVANGING VAN DE STANDAARD KLEPELMAAIER | TERMINAL TOOLS - IN REPLACEMENT OF THE STANDARD MULCHER

HEGGEN TRIMMER HEDGE CUTTING BAR		TAKKEN SNIJDER BRANCH CUTTING BAR		BOSMAAIER SCHIJVEN FOREST DISCS CUTTING BAR		SCHIJVEN BOSMAAIER DISC BRANCH CUTTER		GREPPEL REINIGER DITCH CLEANER	
BF15		BTZ5 15		BD2		DFG12		PF60	
		BTZ5 18		BD3					
		BTZ10 16							
		BTZ10 19							
		BTZ10 22							



BF15



BTZ5/10



BD2/3

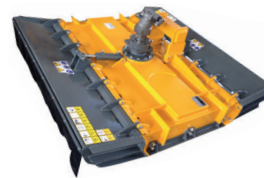

DFG12



PF60